



# Electrolux



**Upright**  
**VACUUM CLEANER**  
Household Type  
**OWNER'S GUIDE**  
**Z2900 SERIES**

**IMPORTANT**

For any advice  
on your cleaner and to  
order dustbags, filters  
and accessories,  
please telephone  
Electrolux  
Customer Care

**08706 055055**

**Index**

Important Information	2-3
Guarantee.....	3
Assembly Parts.....	4
How to Assemble.....	4-5
How to Use .....	5
Accessories .....	6
Filters.....	6
Dustbag .....	6-7
Smartbox .....	7
Brush Roll & Belt .....	8
How to Clear	
Blockages .....	9
Troubleshooting .....	10
Thermal Cut Off.....	10

**Please Retain**

We suggest you record the model, type and serial numbers below. They are located on the silver rating plate on your cleaner. For prompt and complete service information, always refer to these numbers when inquiring about service.

**Model & Type** \_\_\_\_\_

**Serial No.** \_\_\_\_\_

It is also important to keep your receipt as proof of date of purchase.



**The Electrolux Group.**

# IMPORTANT SAFEGUARDS

When using an electrical appliance, basic precautions should always be followed, including the following:

**READ ALL INSTRUCTIONS BEFORE USING THIS VACUUM CLEANER.**

## WARNING

To reduce the risk of fire, electric shock, or injury:

- Do not use outdoors or on wet surfaces.
- **Do not leave vacuum cleaner when plugged in.** Turn off the switch and unplug the electrical cord when not in use and before servicing.
- Do not allow to be used as a toy. Close attention is necessary when used by or near children.
- Use only as described in this manual. Use only manufacturer's recommended attachments.
- Do not use with damaged cord or plug. If vacuum cleaner is not working as it should, has been dropped, damaged, left outdoors, or dropped into water, return it to a service center before using.
- Do not pull or carry by cord, use cord as a handle, close door on cord, or pull cord around sharp edges or corners. Do not run vacuum cleaner over cord. Keep cord away from heated surfaces.
- Do not use extension cords or outlets with inadequate current carrying capacity.
- Turn off all controls before unplugging.
- Do not unplug by pulling on cord. To unplug, grasp the plug, not the cord.
- Do not handle plug or vacuum cleaner with wet hands.
- Do not put any object into openings. Do not use with any opening blocked; keep free of dust, lint, hair, and anything that may reduce airflow.
- This vacuum cleaner creates suction and contains a revolving brush roll. Keep hair, loose clothing, fingers, and all parts of body away from openings and moving parts.
- Do not place cleaner on furniture or stairs as the brush roll may cause damage. Place cleaner on floor with the handle in storage position while using attachments.
- Do not pick up anything that is burning or smoking, such as cigarettes, matches, or hot ashes.
- Do not use without dust bag in place.
- Belt pulleys can become hot during normal use. To prevent burns, avoid touching the belt pulley when servicing the drive belt.
- Use extra care when cleaning on stairs.
- Do not use to pick up flammable or combustible liquids such as gasoline, or use in areas where they may be present.
- Store your cleaner indoors in a cool, dry area.
- Keep your work area well lighted.
- Unplug electrical appliances before vacuuming them.

## SAVE THESE INSTRUCTIONS

### BEFORE YOU START

#### CHECK THE VOLTAGE

First check the voltage shown on the data plate (see rear view) to make sure that the cleaner is of the correct voltage for your electricity supply. If it is not, do not use the cleaner but refer back to your dealer.

#### CONNECTING TO YOUR ELECTRICITY SUPPLY

Permanently connected to the cleaner is a mains supply (2-core) cable fitted with a non-rewirable plug incorporating a 13A fuse.

In the event of the fuse requiring replacement the fuse cover should be removed using a small screwdriver. The old fuse **MUST** be replaced by a 13A ASTA approved BS1362 fuse or a BSI approved fuse. The cover must be replaced before the plug is used again. In the event of loss of the fuse cover, replacements can be obtained from your Electrolux Retailers and must be of the same colour as indicated by the coloured insert on the base of the plug.

If difficulty is experienced in obtaining a replacement, contact Electrolux on 08706 055055.

**In no circumstances must the plug be used without a correct fuse cover fitted.**

If the plug that is fitted to your appliance is not suitable for your socket outlet, it must be cut off and the appropriate plug fitted.

Remove the fuse from the cut off plug.

The cut off plug should then be disposed of to prevent the hazard of shocks in case it should be plugged into a 13 amp socket in another part of your home.

The wires in the mains cable of this appliance are coloured in accordance with the following code: **Blue: Neutral. Brown: Live.**

As the colours of the wires in the mains cable of this appliance may not correspond with the coloured markings identifying the terminals in your plug, proceed as follows:

The wire which is coloured blue must be connected to the terminal which is marked with the letter N or coloured black.

The wire which is coloured brown must be connected to the terminal which is marked with the letter L or coloured red.

If using a three-pin plug, do not make any connection to the terminal marked with the letter E or by the earth symbol or coloured green or green-and-yellow. This cleaner is double insulated and no earth connection is necessary.

It is in your interest to ensure that the plug is correctly attached to the mains cable. In case of doubt, have it done by a qualified electrician, as Electrolux cannot regard the repair of faults on the plug connection as a service that can be given free of charge under the terms of the guarantee.

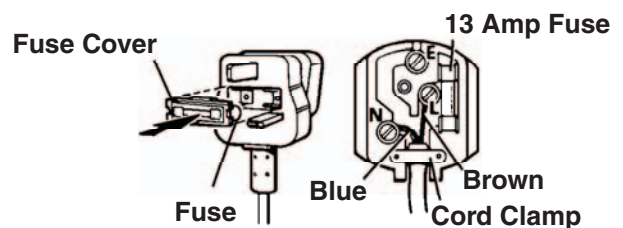

## BEFORE YOU START (continued)

### WARNING

**The brush in the cleaning head rotates at high speed and can cause damage to the mains supply cable if the cleaner passes over it during cleaning operations.**

Care should be taken to ensure that this does not happen. If the cleaning head has accidentally passed over the mains supply cable the following action should be taken:

1. Switch off and remove the plug from the socket outlet.
2. Examine the mains supply cable for damage (only after removing the plug from the socket outlet).
3. If there is any sign of damage to the supply cable it **MUST** be renewed. The repair **MUST** be carried out by an Electrolux Service Agent or a similar qualified person.
4. **NEVER** use the machine with a damaged mains supply cable.

#### Proprietary carpet conditioning and air freshening materials

After using proprietary carpet conditioning powders, it is recommended that the dustbag or filters be changed. Some of these preparations contain substances which if left in the vacuum cleaner for extended periods could damage the plastic mouldings which form the structure of the cleaner.

Many air fresheners, household deodorants, sprays and polishes contain a highly flammable gas propellant.

Because of this, it is particularly important that these products are used strictly in accordance with the relevant manufacturer's instructions. It is essential that none of the above products are sprayed directly into the vacuum cleaner or any of its filters, hose assembly, dustbag chamber or dust cup.

### SERVICE

Should you require service on your Electrolux cleaner, please telephone Electrolux on 08706 055055. Before requesting service, please check whether your problem is covered under the Service Checklist (see below).

New filter pads, dustbags, brush rollers and drive belts can be obtained from Electrolux Retailers. If difficulty is experienced in obtaining spares, please contact Electrolux on **08706 055055**.

### SERVICE CHECKLIST

- If your cleaner will not operate, check the plug connection, plug fuse and mains fuse.
- **Never allow** the dustbag/Smartbox to become so full that it impedes the air-flow, thus reducing the cleaning efficiency of the machine. The character of household dust and its effect on the air-flow through the machine may vary considerably. Fluffy dust allows air to pass through readily whereas fine powdery dust or proprietary cleaning powders, pack tightly in the dustbag, offering greater resistance to air-flow and will reduce cleaning efficiency if the bag becomes overloaded. Always ensure that you have a spare genuine Electrolux dustbag.
- **Always store** your cleaner and spare dustbags/filters in a dry place.
- **Renew** the filter pads three or four times a year. This is essential to ensure continued high filtration of dust particles.
- **Sucking up** such items as stockings, clippings of cloth, sizeable pieces of paper, wrappings from cigarette packets or sweets etc., may block the hose. **Electrolux regrets that the clearing of blocked hoses cannot be regarded as service that can be given free of charge, under the guarantee.** Should a blockage occur, first disconnect the cleaner from the electricity supply,

to section headed "Blockages". If these operations are not successful, contact us on 08706 055055.

- **Never** pick up hot cinders or lighted cigarette ends.
- **Make certain that your cleaner does not come into contact with water or any other liquid. It is not designed as a wet pick up cleaner, and must never be used on damp carpets or wet floors.**

Important - in the event of the mains supply cable of this vacuum cleaner requiring replacement, we recommend that this be carried out by Electrolux Service Staff.

### Spares

New filters, dustbags, brush rollers and drive belts can be obtained from Authorised Electrolux Dealers and electrical retailers. If difficulty is experienced in obtaining spares please call us on **08706 055055**.

### Guarantee

**This guarantee is in addition to your statutory and other legal rights.**

**This product is for household use only.**

Electrolux products are carefully designed, manufactured, tested and inspected and, in consequence, we undertake to replace or repair any part found to be defective in material or workmanship, within one year of delivery to the original purchaser, free of charge. You may be required to take the product to your nearest service provider if the product requires attention during the first year.

There are certain conditions which may invalidate this guarantee:

- a. It is dependent upon the appliance being correctly installed and used in accordance with the Company's instructions under normal domestic conditions within the United Kingdom or the Republic of Ireland.
- b. Service at all times must be carried out by an Electrolux Service Representative or authorised agent.
- c. The guarantee may be invalidated by unauthorised repair or modification of the appliance.
- d. You may be charged by Electrolux if you call for an engineer to resolve a problem that we believe is covered in the instruction booklet. (example: blocked/dirty filters)

The Company does not accept liability for defects arising from neglect, misuse or accident. This guarantee excludes such normal wearing parts as drive belts, brushes, filters and dustbags as the life of these depends upon the amount and nature of use.

Proof of the date of purchase will be required before service under guarantee is provided. Please call **08706 055055** for assistance.

#### Important:

For future reference we suggest you record the following details here, and keep the receipt with this handbook as proof of purchase.

Purchased from \_\_\_\_\_

Date purchased \_\_\_\_\_ Model no \_\_\_\_\_

## Assembly Parts

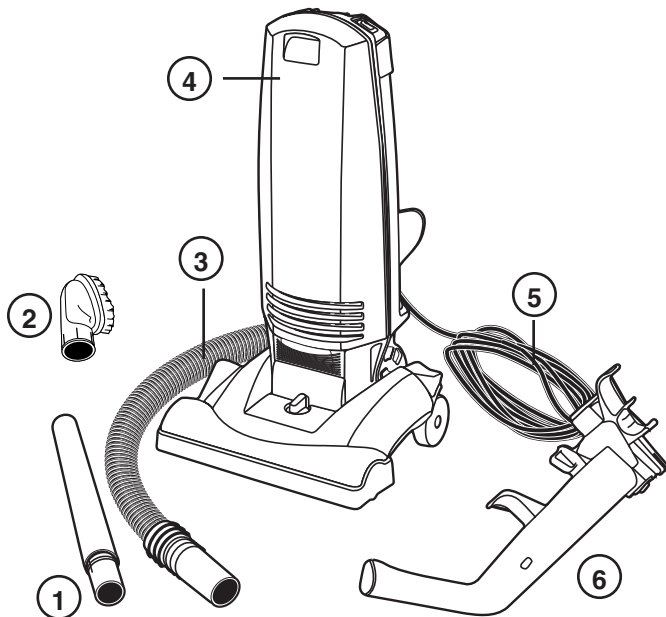

- ① Nested extension tubes and Crevice Nozzle (Pull apart.)
- ② Dusting Brush.
- ③ Hose.
- ④ Vacuum Cleaner Body.
- ⑤ Electrical Cord.
- ⑥ Handle.
- ⑦ Screws located in the accessory package.

## How To Assemble

**CAUTION:** Assemble the cleaner before using.

**CAUTION:** Moving parts, make sure ON/OFF switch is in the OFF position before plugging in.

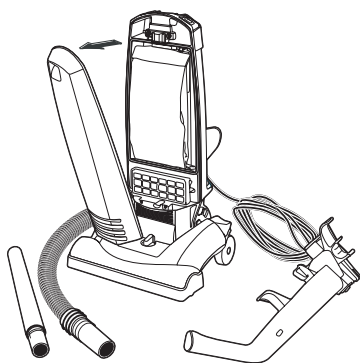

- ① Grasp dustbag/Smartbox cover handle and pull away from vacuum body to remove door.

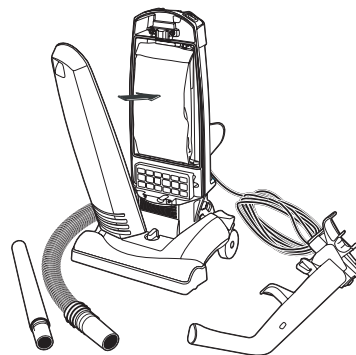

- ④ Place the tabs on the bottom of the dustbag/Smartbox cover into slots at the bottom of the bag compartment and rotate door up and push against the vacuum body until it snaps shut.

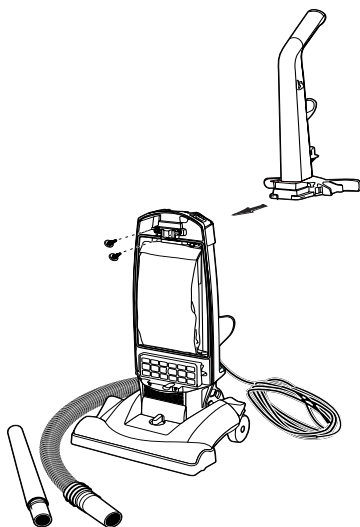

- ② Slide the handle into the grooves at the top of the vacuum body as shown.
- ③ Place the two screws (supplied) into the holes at the top of the dustbag/Smartbox compartment and tighten with a screwdriver.

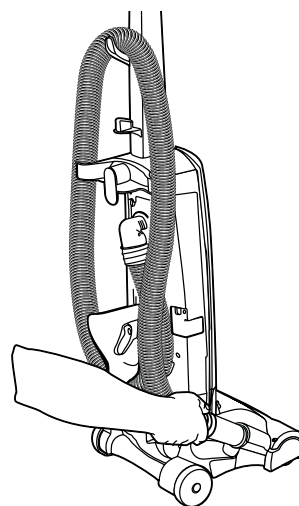

- ⑤ Place the hose on the back of the vacuum, wrapping it up and over the hose hook as shown.
- ⑥ Firmly push the end of the hose into the hose retainer in the hood of the vacuum.

## How To Assemble (continued)

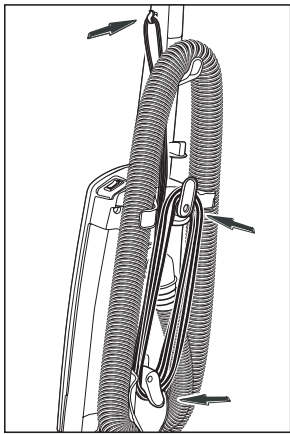

- 7 Pull the electrical cord up to the cord retainer and firmly push down into retainer. This will keep the cord out of the way the next time you vacuum.
- 8 Wind the cord around the two cord hooks on the back of the vacuum.
- 9 Secure plug to the cord to prevent unwinding.

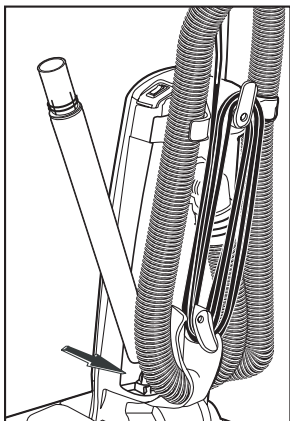

- 10 Store the extension tubes on the side of the vacuum in front of the hose.

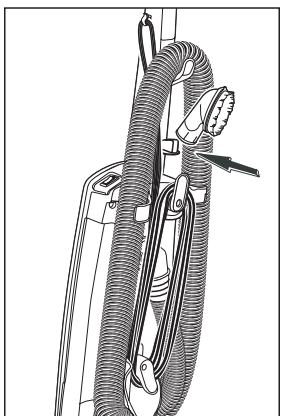

- 11 Store the dusting brush.

## How To Use

**WARNING: Avoid injury. Keep loose clothing, hair, fingers, and all other parts of body away from any moving part (such as the revolving brush). Turn off the switch and unplug the cleaner before changing the floor type selector.**

### ON/OFF Switch.

International symbol **I** means On, International symbol **O** means Off.

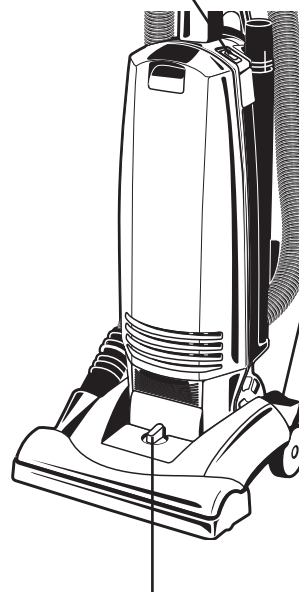
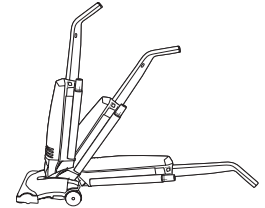

**Handle Release.** Step on handle release to pull handle back to a comfortable operating position. To lower handle completely to the floor, depress handle release a second time.

### Helpful Information:

Before cleaning under low furniture, check area first for objects that might harm the cleaner or block the vacuum hose.

**Floor Type Selector.** An adjustment that raises or lowers the cleaner base to match the type of floor surface. With the cleaner cord unplugged, set the adjustment to lowest setting for maximum carpet cleaning. **If the cleaner is difficult to push, move adjustment to next highest setting until cleaner is comfortable to push.** The brush roll must reach the carpet for effective cleaning. For ease in moving the adjustment knob, place handle in operating position and tilt cleaner back to remove weight from front wheels.

### Helpful Information:

**Listen** to your cleaner. If you notice a change in the sound of the motor or a change in performance, it could simply indicate a common usage or maintenance issue. Such as, a need to raise or lower the carpet height adjustment, possible blockage in hose or brush roll area, or a broken or loose brush roll belt. These are all easy to fix and the instructions are included in this handbook. Becoming familiar with the information in this guide will help you to get the best possible performance from your new cleaner for many years to come.

## How To Use (continued)

**NOTE:** While using accessories, do not place cleaner on furniture or steps as the brush roll may cause damage. Place cleaner on floor with the handle in storage position.

1. To use accessories remove hose from hose retainer in hood of cleaner by lifting up and twisting.
2. Place desired accessory onto end of hose or extension tubes.

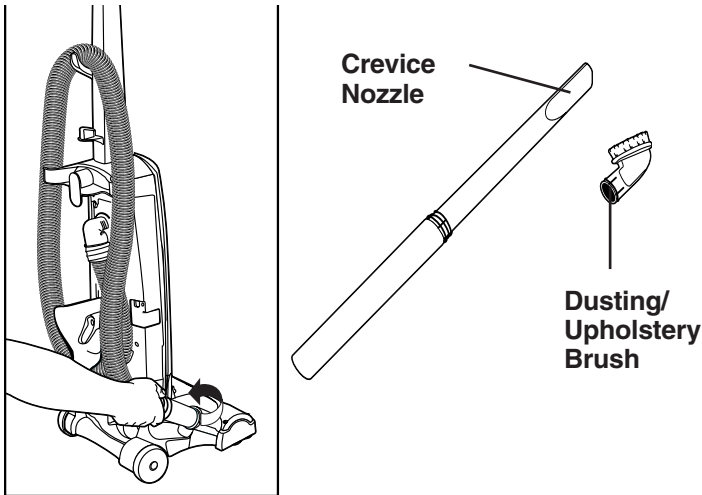

**Dusting/Upholstery Brush** is for furniture, blinds, books, lamp shades, shelves, curtains, draperies, cushions and fabrics.

**Crevice Nozzle** cleans corners, stairs, skirting boards, and between cushions.

**Nested extension tubes** to add reach.

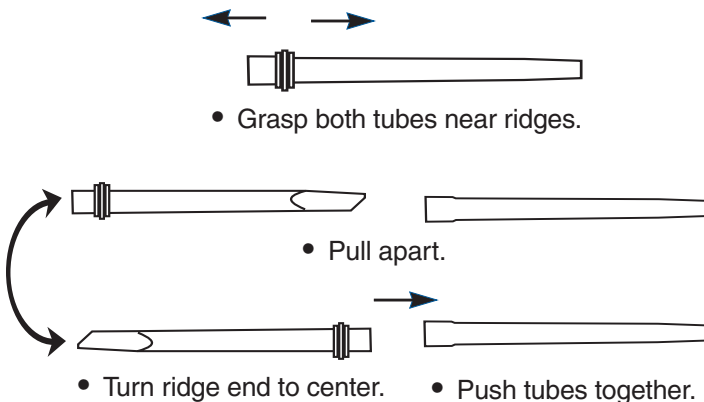

The instructions in this booklet serve as a guide to routine maintenance. To avoid unnecessary service calls, check the dustbag, filters, belt, and brush roll often.

## Routine Maintenance

**NOTE:** Turn off the switch and unplug the electrical cord before routine maintenance. Never operate the vacuum cleaner without the dustbag/Smartbox or filter assembly in place.

**NOTE:** When vacuuming using carpet fresheners or cleaners, powder, plaster dust, or similar fine substances, the dustbag/Smartbox and filters will require more frequent maintenance.

## Models Z2901 Z2905 Z2910

### Removing the Dustbag E82:

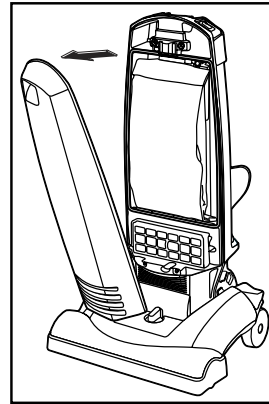

Remove dustbag cover.

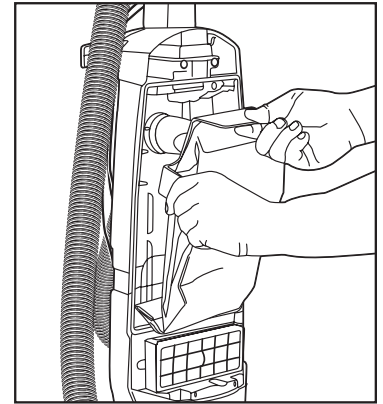

Grasp dustbag flaps and pull dustbag from cleaner.

Check the **filters** each time the dustbag or Smartbox is changed. Clean or replace as needed.

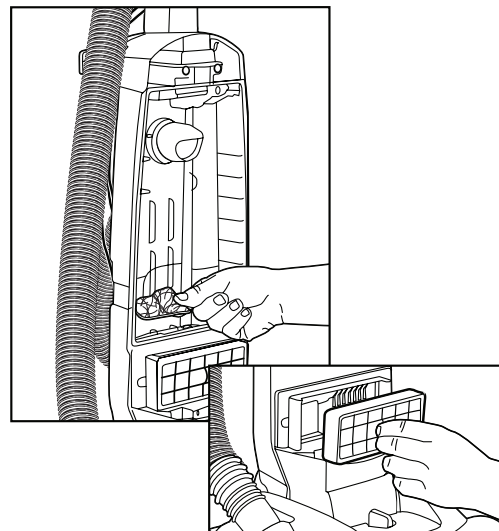

Shake filter to remove excess dust. If necessary, the filters can be cleaned by vacuuming with another cleaner.

Micro filter ref: EF2  
HEPA filter ref: EF82

## Routine Maintenance (continued)

### Installing New Dustbag Ref: E82

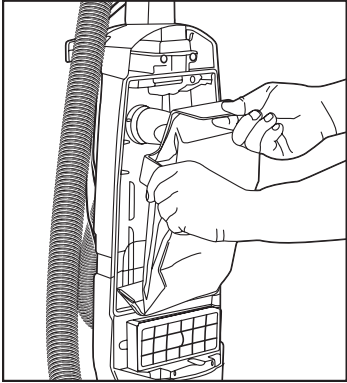

Fold dustbag flaps of new bag back and slide into unit. Make sure inlet goes into opening on dustbag.

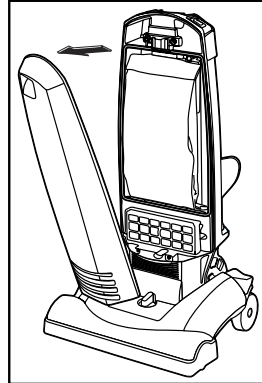

Replace dustbag cover on unit.

**NOTE: Dustbag cover cannot be closed unless the dustbag is installed properly.**

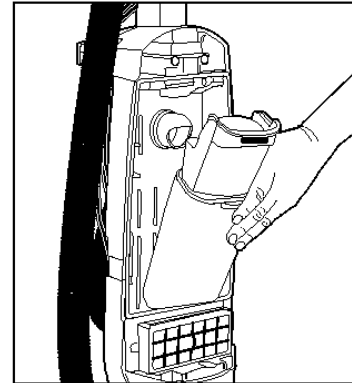

Pull the Smartbox out of the cleaner.

## Models Z2915 Z2920 Z2925

### Emptying and Cleaning the Smartbox

**NOTE: Switch cleaner off at the mains and remove plug from the electricity supply before emptying or cleaning the Smartbox.**

#### Emptying the Smartbox:

It is important to empty the smartbox regularly. **DO NOT** allow the Smartbox to become too full.

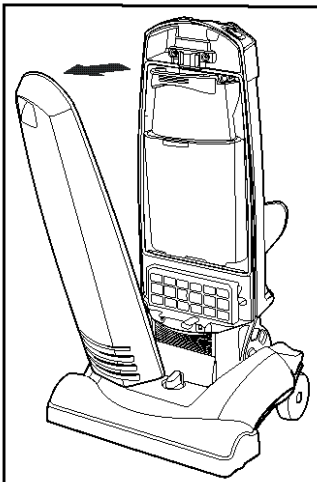

Remove dustbag/Smartbox cover.

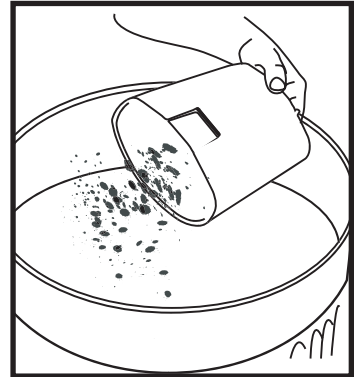
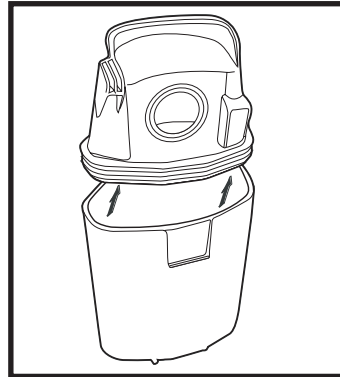

Pull the Smartbox apart and empty the dust and debris into a dustbin. Brush out the smartbox to remove the excess.

#### Washing the Smartbox:

The Smartbox can be washed in warm water. A small amount of washing up liquid may be added. A brush may be used to remove stubborn dust. Rinse the Smartbox thoroughly and remove the excess water with a dry cloth. Dry the dust container thoroughly (24 hours is preferred) before refitting to the cleaner.

## Periodic Maintenance

**NOTE:** Turn off the switch and unplug the electrical cord before periodic maintenance. Never operate the vacuum cleaner without the dustbag/Smartbox or filter assembly in place.

### Brush Roll

The brush roll turns as it sweeps and combs the carpet pile. Remove hair and threads from the brush roll so it continues brushing the carpet. To maintain the most efficient cleaning, the bristles must touch the carpet.

### Brush Roll Belt

The brush roll belt turns the brush roll to agitate, sweep, and comb the carpet pile. Check the belt regularly to be sure it is in good condition. Replace the belt if it stretches, cracks or loses tension. Cut away any hair or threads wound around the brush roll or the belt pulley because the buildup could cause the belt to rotate unevenly.

## How To Replace Brush Roll Belt

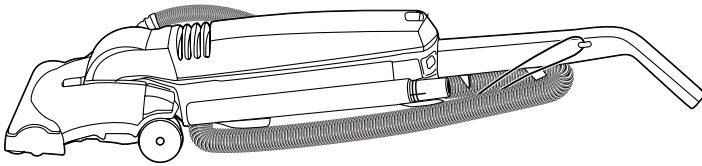

1. Lower handle to floor to change belt.

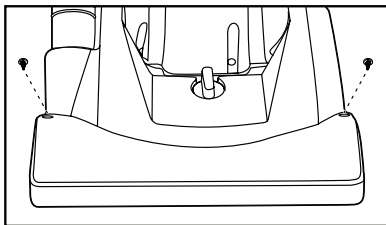

2. Remove the two screws from the top of the hood.

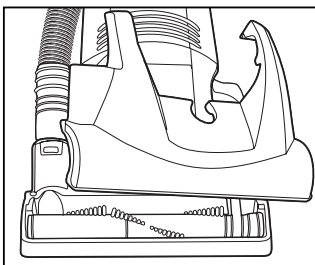

3. Lift hood to remove.

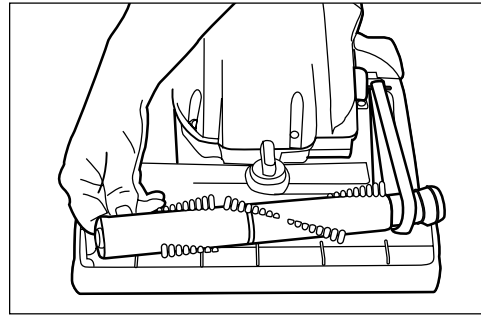

4. Lift left end of brush roll.
5. Remove and discard belt.
6. Place new belt around motor shaft.
7. Place new belt around brush roll pulley.

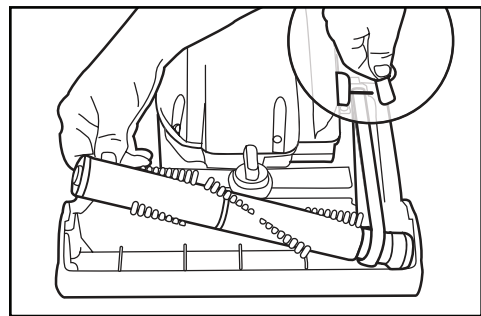

8. Align left end cap with base. Push end cap securely into place.
9. Pull right side of brush roll to stretch belt. Secure right end cap into base.

### **IMPORTANT**

**10. Rotate brush roll by hand two full rotations to properly position belt.**

11. Place hood back on cleaner. Replace and tighten two screws.
12. Return vacuum to upright position.



## To Clear Blockages in Hose

**NOTE:** Turn off the switch and unplug the electrical cord before clearing hose.

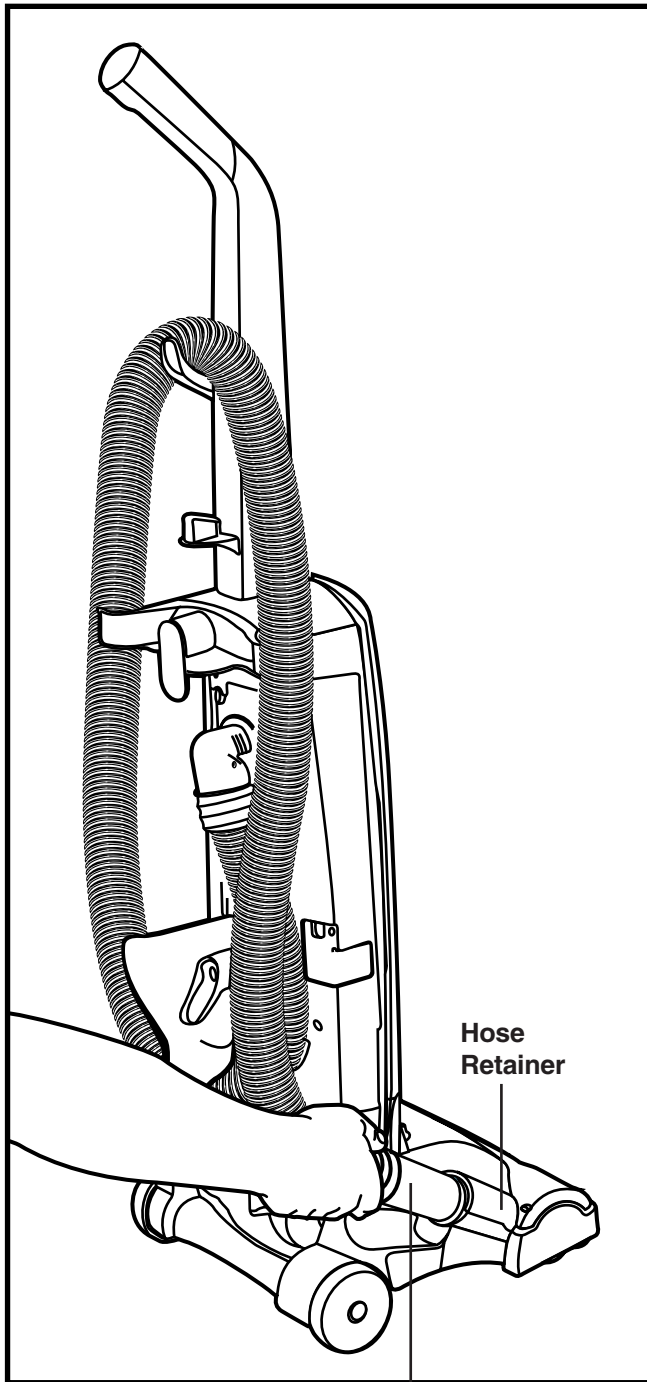

1. Firmly pull the end of the hose from the hose retainer on the hood of the vacuum.
2. Check for blockages in the hose and hose retainer. Flexing the hose may help loosen any blockage. **If no blockage is found, continue to step 4.**

If blockage is found, clear the blockage and replace the hose in the hose retainer. **If the blockage is in the hose retainer and cannot be cleared, continue to step 3.**

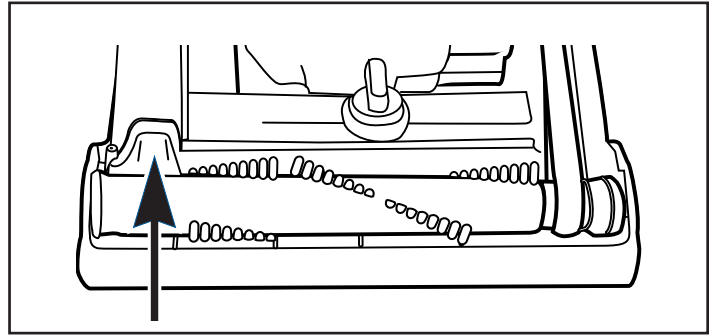

3. Remove the hood from the cleaner and check for a blockage in the brush roll area. Make sure the hose inlet is clear. **If no blockage is found, continue to step 4.**

After the blockage is found and cleared, replace the hood on the cleaner.

4. Twist the hose from the coupling elbow on the back of cleaner. Check for blockages at cleaner opening and in hose. If a blockage is found, clear the blockage.

The two screws attaching the clear hose adapter can be removed for better access to a blockage.

5. Screw the hose back onto the back of the cleaner and replace the other end of the hose into the hose retainer on the hood of vacuum.

**NOTE: Turn off the switch and unplug the electrical cord before servicing.**

PROBLEM	CAUSE	SOLUTION
Motor will not start.	<input checked="" type="checkbox"/> Electric Plug	<input type="checkbox"/> Push plug securely into outlet. <input type="checkbox"/> Try another outlet. <input type="checkbox"/> Check circuit breaker.
Motor suddenly stops.	<input checked="" type="checkbox"/> Thermal Cut Off	<input type="checkbox"/> See below.
Does not clean the carpet or floor.	<input checked="" type="checkbox"/> Filters  <input checked="" type="checkbox"/> Dustbag  <input checked="" type="checkbox"/> Hose  <input checked="" type="checkbox"/> Belt <input checked="" type="checkbox"/> Brush Roll	<input type="checkbox"/> Clean or replace the filters. <b>Hint:</b> If picking up fine dust, the filters may <u>not</u> look dirty but a fine substance tends to reduce suction when it blocks the airflow through the filter(s). Page 5. <input type="checkbox"/> Replace the dustbag with a new dustbag. Page 6. <input type="checkbox"/> Be sure the dustbag or Smartbox is properly seated into the cleaner body. Page 6. <input type="checkbox"/> Be sure hose adapter is secure on back of cleaner. Page 9. <input type="checkbox"/> Remove any blockages from the hose that restrict the airflow. Page 9. <input type="checkbox"/> Check to see that the end of the hose is firmly pressed into the hose retainer in the hood of the vacuum. <input type="checkbox"/> Check base hose and long hose. Page 8. <input type="checkbox"/> Replace a broken, cut, loose or out of shape belt. <input type="checkbox"/> Clean hair and thread from bristles and end cap area. Replace brush roll if bristles are worn.
No suction at the end of hose.	<input checked="" type="checkbox"/> Hose Adapter <input checked="" type="checkbox"/> Filters  <input checked="" type="checkbox"/> Hose  <input checked="" type="checkbox"/> Dustbag	<input type="checkbox"/> Be sure hose adapter is secure. Page 9. <input type="checkbox"/> Clean or replace the filters. <b>Hint:</b> If picking up fine dust, the filters may <u>not</u> look dirty, but a fine substance tends to reduce suction when it blocks the airflow through the filters. <input type="checkbox"/> Remove any clogs from the hose that restrict the airflow. Check base hose and long hose. Page 9. <input type="checkbox"/> Change dustbag.
Noise from the brush roll area.	<input checked="" type="checkbox"/> Brush Roll  <input checked="" type="checkbox"/> Belt	<input type="checkbox"/> Remove hood and clean debris or items from the brush roll area. <input type="checkbox"/> Replace a broken, cut, loose or out of shape belt. Page 7.
Cleaner is hard to push.	<input checked="" type="checkbox"/> Floor Type Selector  <input checked="" type="checkbox"/> Belt	<input type="checkbox"/> Put handle in operating position. Tilt the cleaner back to raise the front wheels off floor. Then turn the knob to a higher setting. <input type="checkbox"/> Replace a broken, cut, loose or out of shape belt. Page 7.
Cleaner height knob will not turn.	<input checked="" type="checkbox"/> Floor Type Selector	<input type="checkbox"/> <b>Hint:</b> Put handle in operating position. Tilt the cleaner back to raise the front wheels off floor. Then turn the knob.
Missing parts		<input type="checkbox"/> Call 08706 055055. Know the model and serial numbers when you call.
Questions?		<input type="checkbox"/> Call 08706 055055. Know the model and serial numbers when you call.

## Thermal Cut Off

This vacuum cleaner has a special thermostat that protects the cleaner in case of motor overheating. If the cleaner suddenly shuts off, push the on/off switch off (0) and unplug the cleaner. Check the cleaner for a possible source of overheating such as a full dustbag, a blocked hose or clogged filter. If these conditions are found, fix them and wait at least 30 minutes before attempting to use the cleaner. After the 30 minute period, plug the cleaner back in and push the on/off switch on (I). If the cleaner still does not run, please call Electrolux Customer Care on 08706 055055.



The symbol  on the product or on its packaging indicates that this product may not be treated as household waste. Instead it shall be handed over to the applicable collection point for the recycling of electrical and electronic equipment. By ensuring this product is disposed of correctly, you will help prevent potential negative consequences for the environment and human health, which could otherwise be caused by inappropriate waste handling of this product. For more detailed information about recycling of this product, please contact your local city office, your household waste disposal service or the shop where you purchased the product.

**Questions?**  
**Call**  
**08706 055055**

---

**Thank you for purchasing an  
Electrolux cleaner.**

**Don't Forget to Use  
Genuine Electrolux  
Bags and Belts**

**CAUTION:** Damages caused by the use of non-genuine Electrolux bags are not covered by the Electrolux Limited Warranty.

** Electrolux**

**101 Oakley Road, LUTON, BEDFORDSHIRE, LU4 9QQ**

Features of the Electrolux vacuum cleaner and accessories supplied with it are protected in Great Britain and abroad by Patents or Registered Designs.

This appliance conforms with the requirements of the amended E.E.C. directive No. 89/336/EEC relating to electromagnetic compatibility (EMC) CE.

Electrolux may introduce modifications to their products from time to time, and consequently the details given in this booklet are subject to alteration without notice.